

- D** **Anhängevorrichtung** Montage- und Betriebsanleitung, Originalbetriebsanleitung
- CZ** **Závěsné zařízení** Montážní a provozní návod
- DK** **Anhængertræk** Montage- og driftsvejledning
- E** **Enganche** Instrucciones de montaje y de servicio
- F** **Attelage** Notice de montage et d'utilisation
- FIN** **Perävaunun vetolaite** Asennus- ja käyttöohjeet
- GB** **Tow bar** Installation and Operating Instructions
- GR** **Διάταξη ζεύξης** Οδηγίες συναρμολόγησης και λειτουργίας
- H** **Vonóhorog** Beszerelési utasítás
- I** **Gancio di traino** Istruzioni di montaggio e per l'uso
- N** **Tilhengerfeste** Monterings- og bruksanvisning
- NL** **Trekhaak** Montage- en gebruikshandleiding
- PL** **Hak holowniczy** Instrukcja montażu i eksploatacji
- RUS** **Фаркоп** Инструкция по монтажу и эксплуатации
- S** **Dragkrok** Monterings- och bruksanvisning

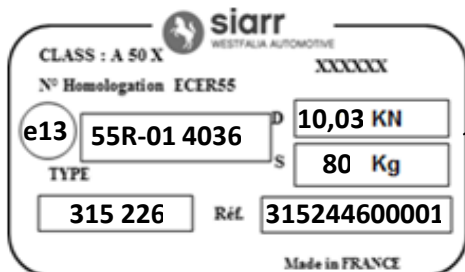

315 244 600 001

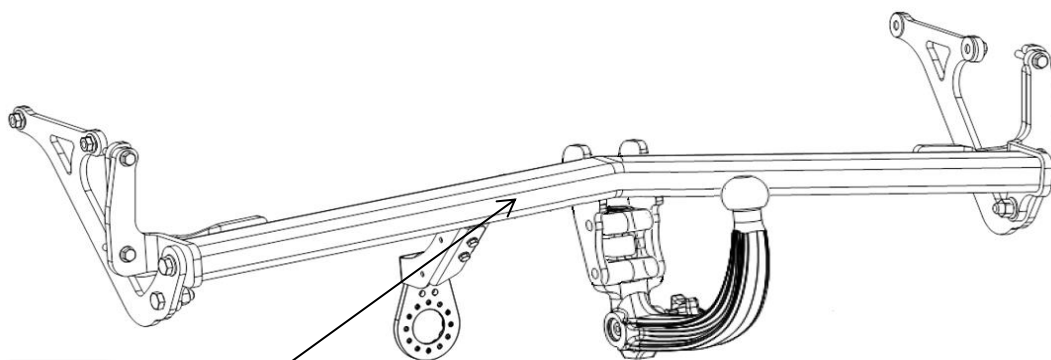







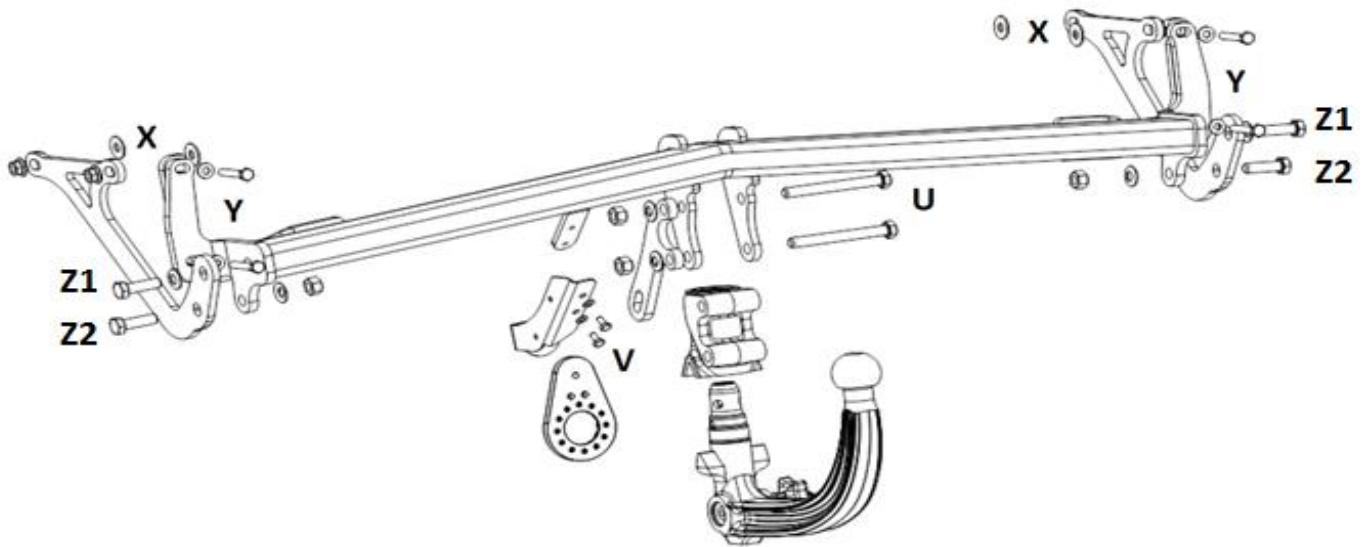





PEUGEOT 3008 - 06/2016 >

OPEL GRANDLAND X - 2017 >

CITROEN C5 AIRCROSS - 2018 >

315244600001



X		M 10 - cl10 - 40 Nm	x 4
		L 10,5 x 27 x 2	x 4
Y		M 8 x 50 - cl 10.9 - 25 Nm	x 4
		CS 8 / 18	x 4
Z1		M 12 x 40 - Cl 10.9 - 110 Nm	x 2
		C 13/29	x 2
Z2		M 12 x 40 - Cl 10.9 - 110 Nm	x 2
		C 13/29	x 2
		M12 Cl10	x 2
U		HM 12 x 110 - Cl 10.9 - 110 Nm	x 2
		M 12 - Cl 10	x 2
		CS 12 / 24	x 2
V		M 6 x 12 - Cl 8.8 - 8 Nm	x 2
		CS 6 / 12	x 2

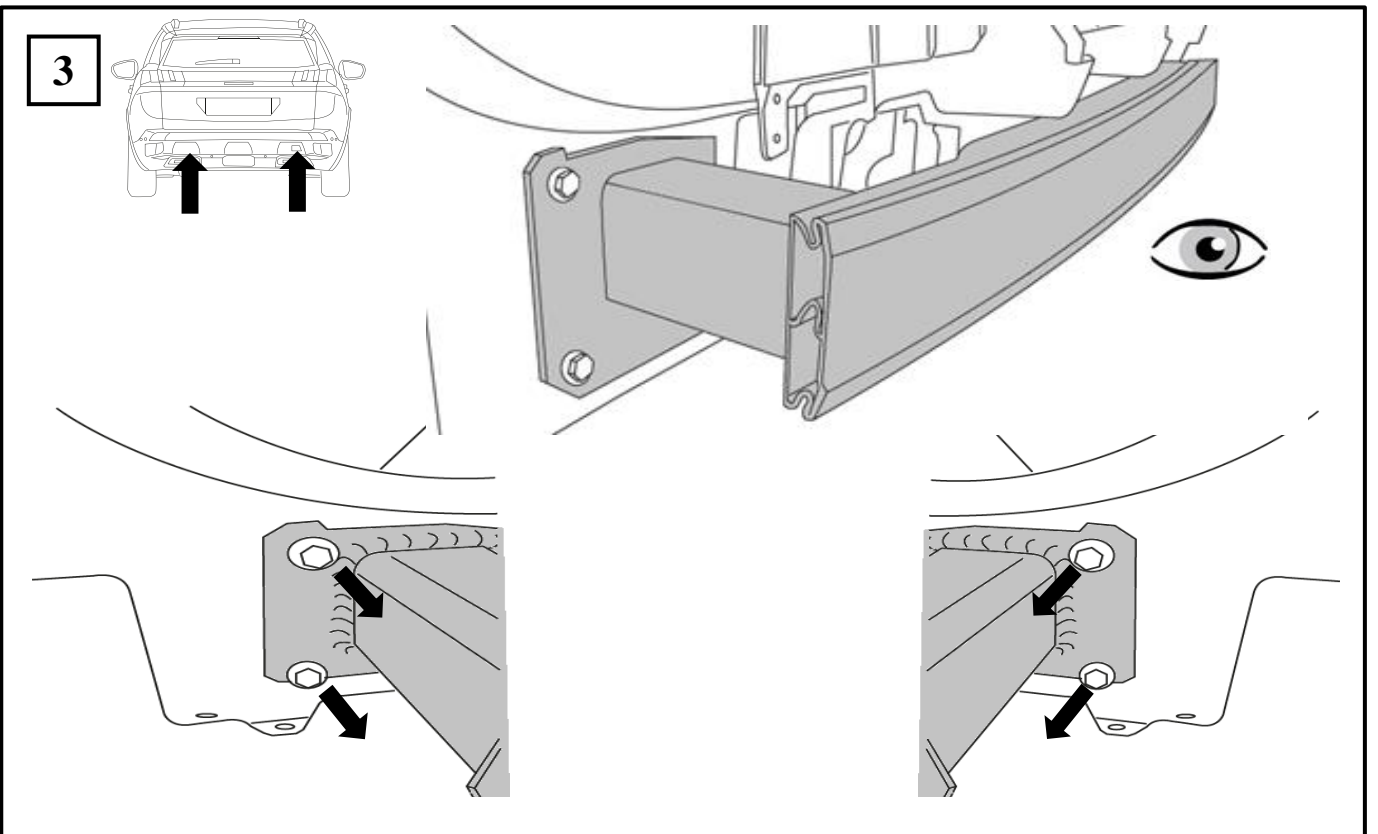
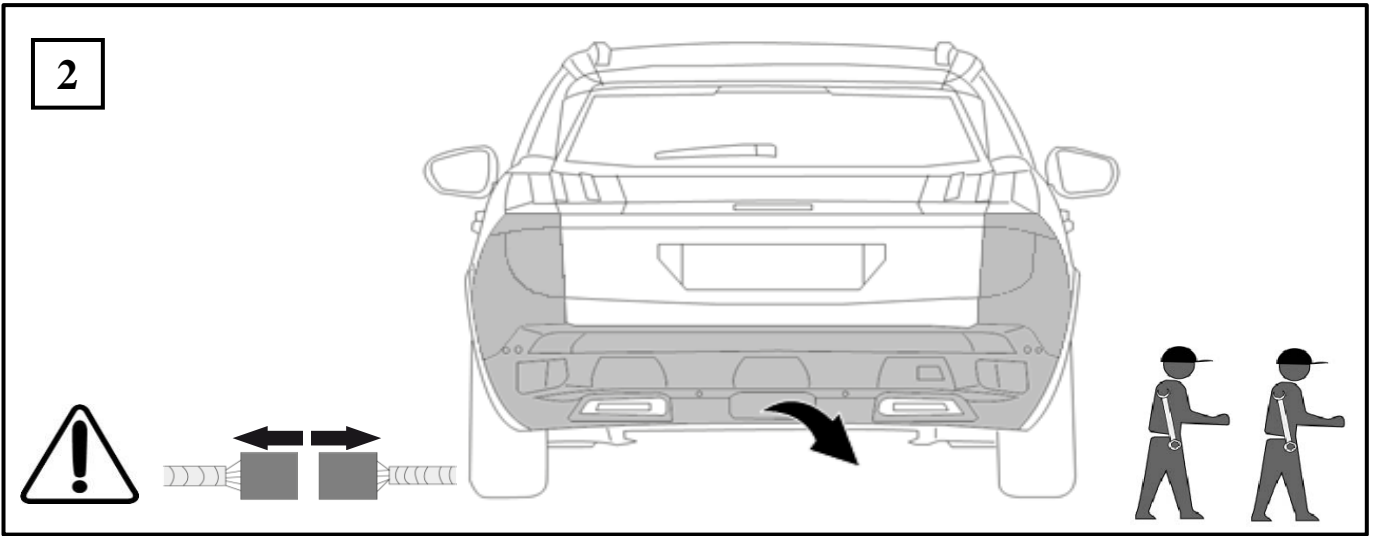
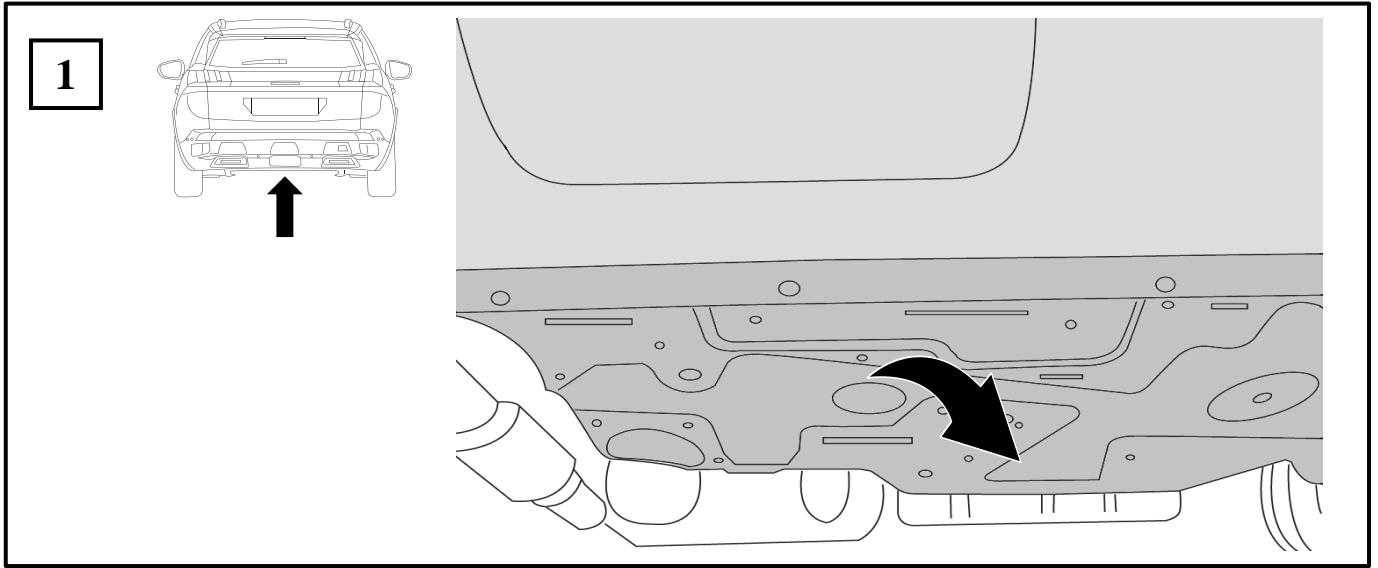

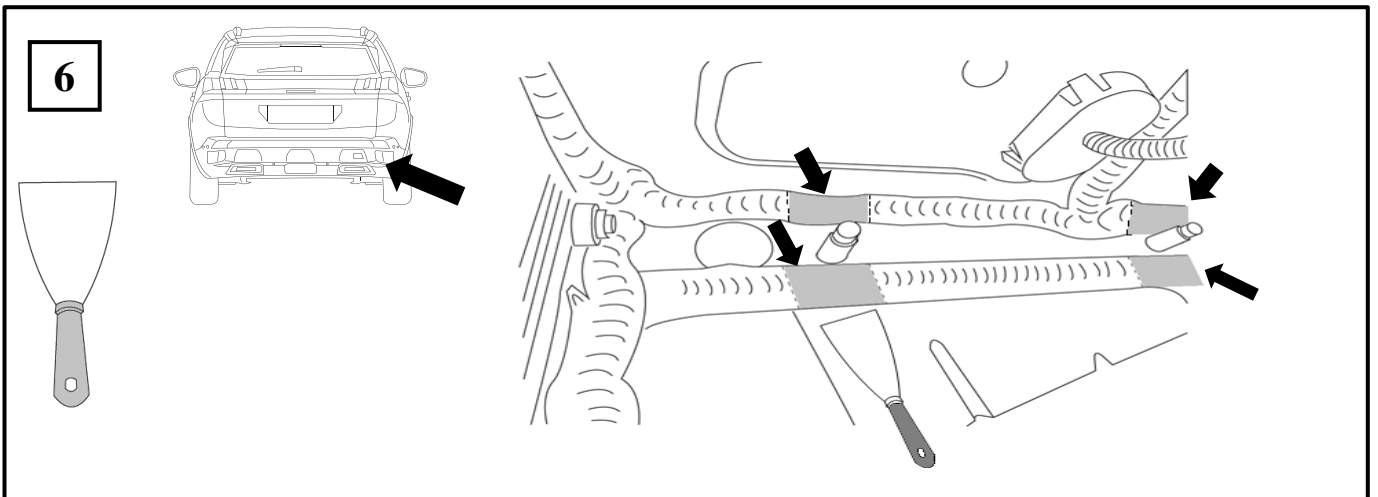
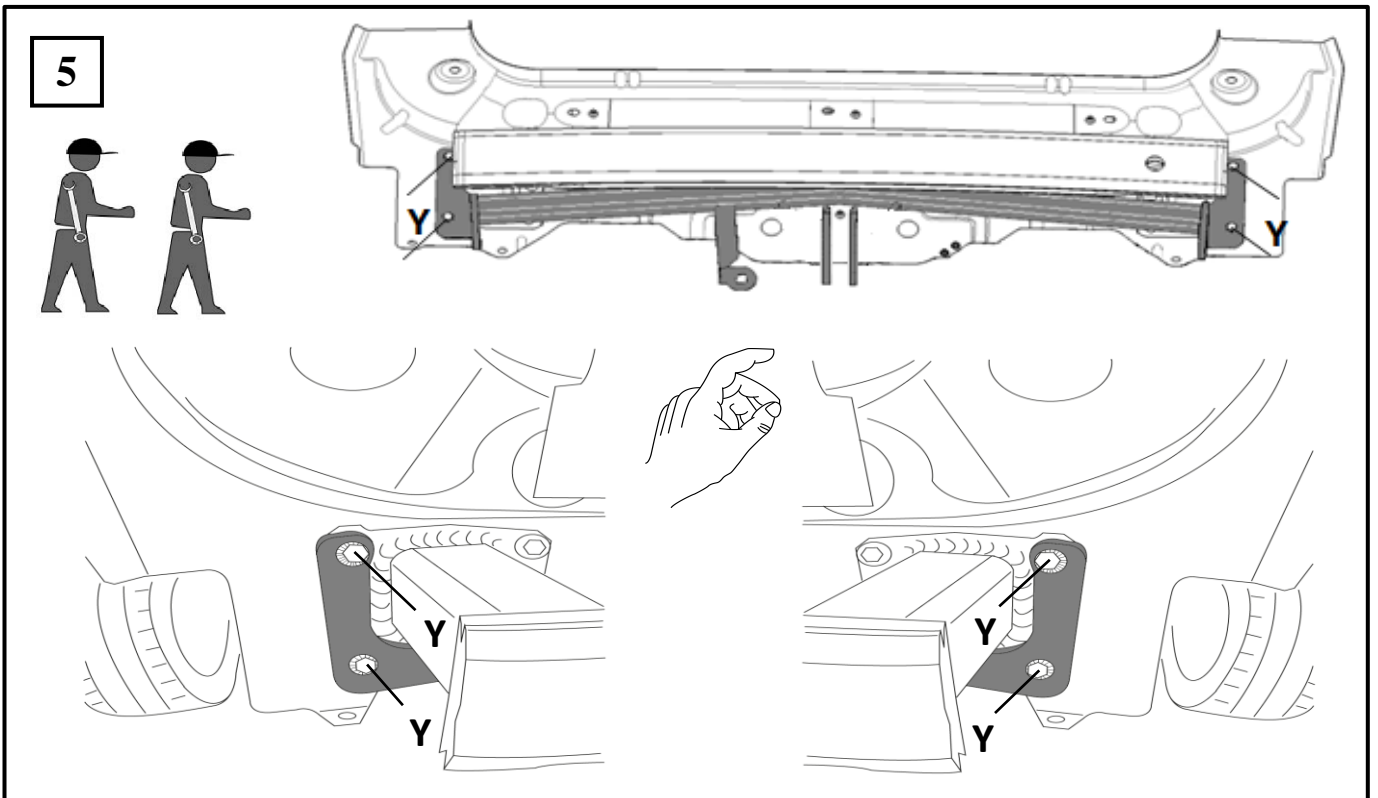
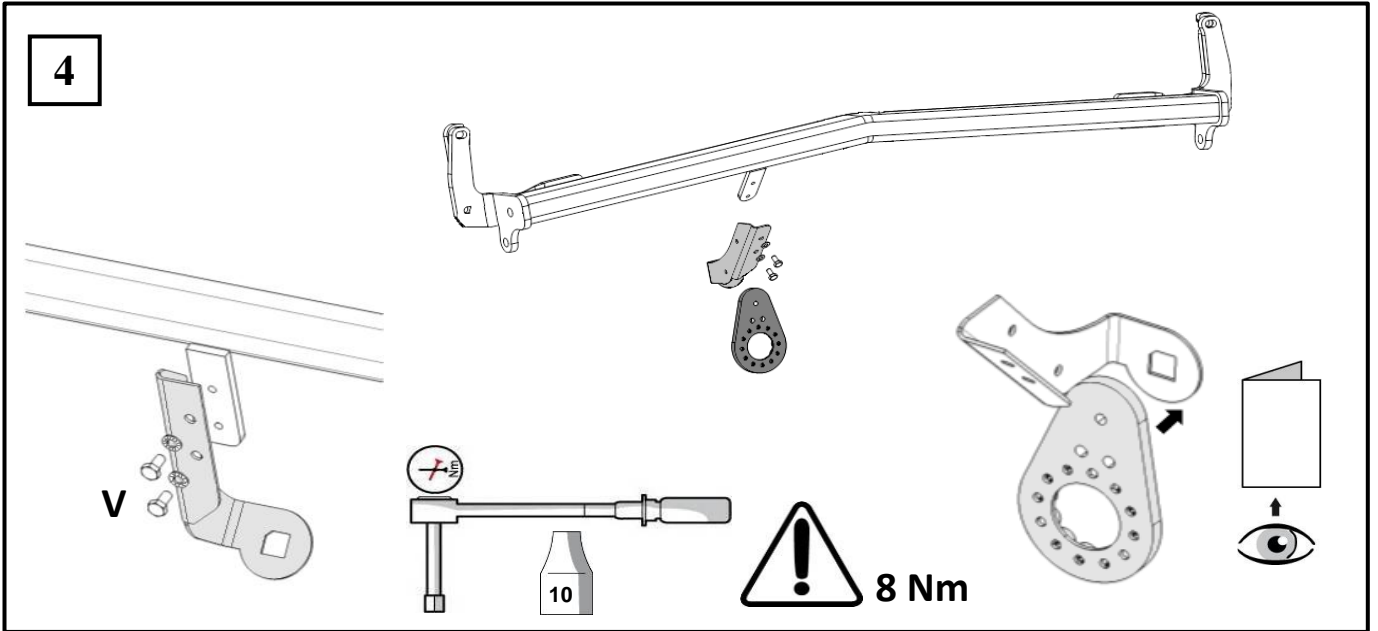

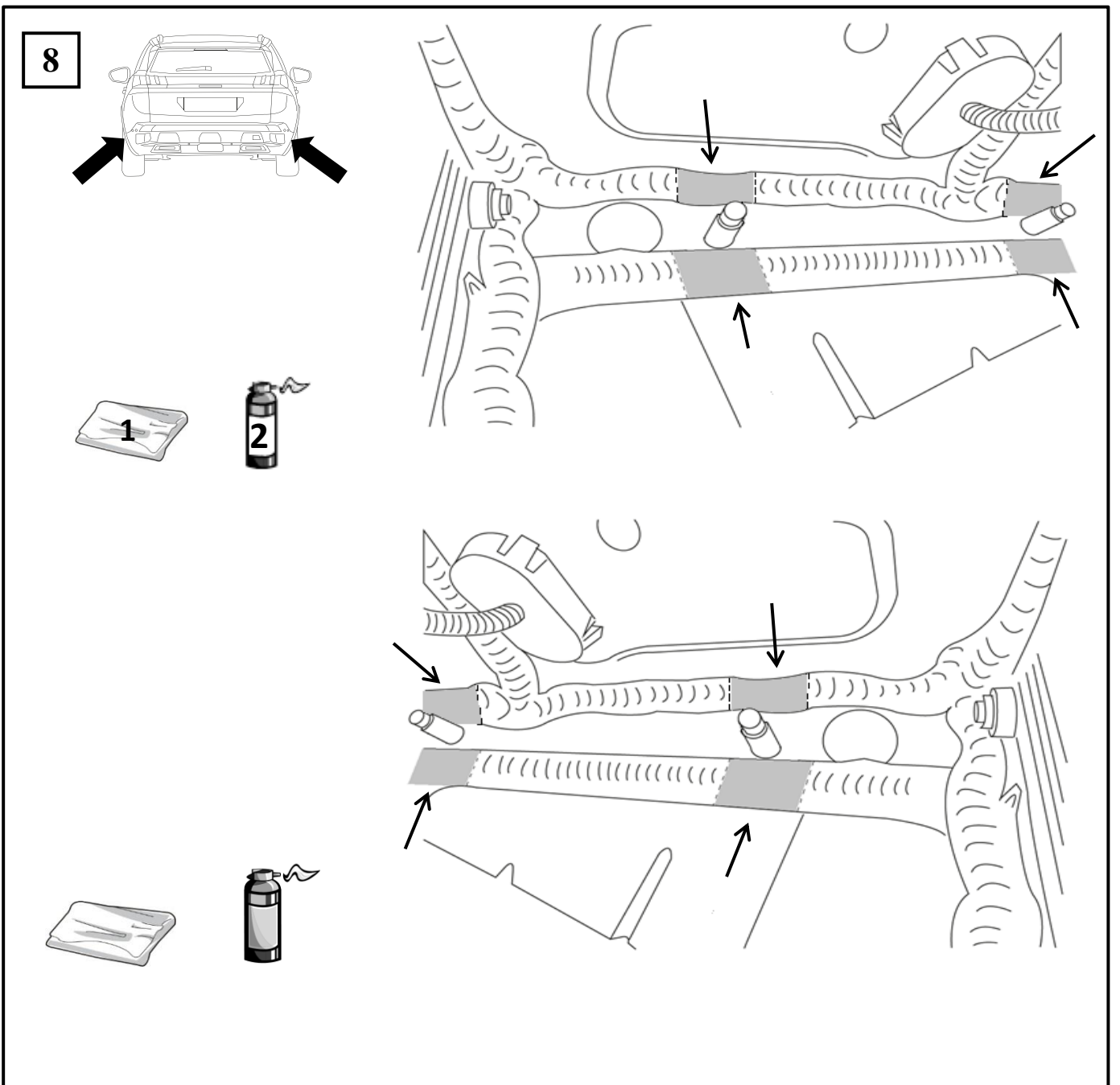
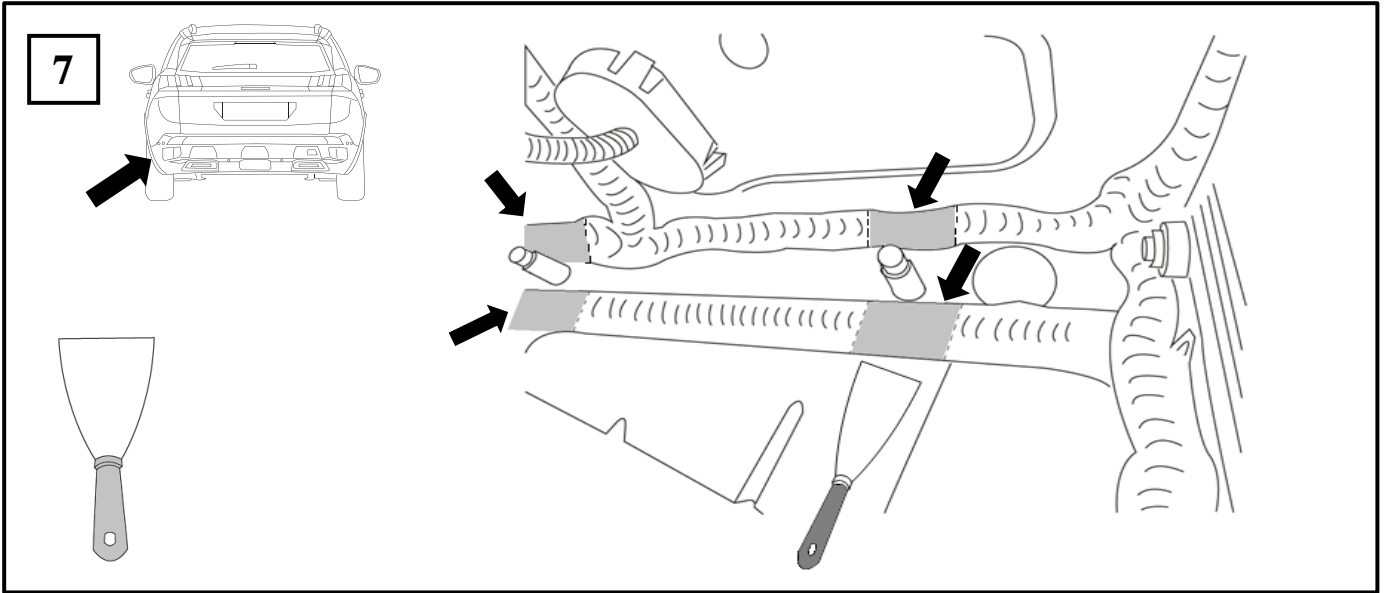

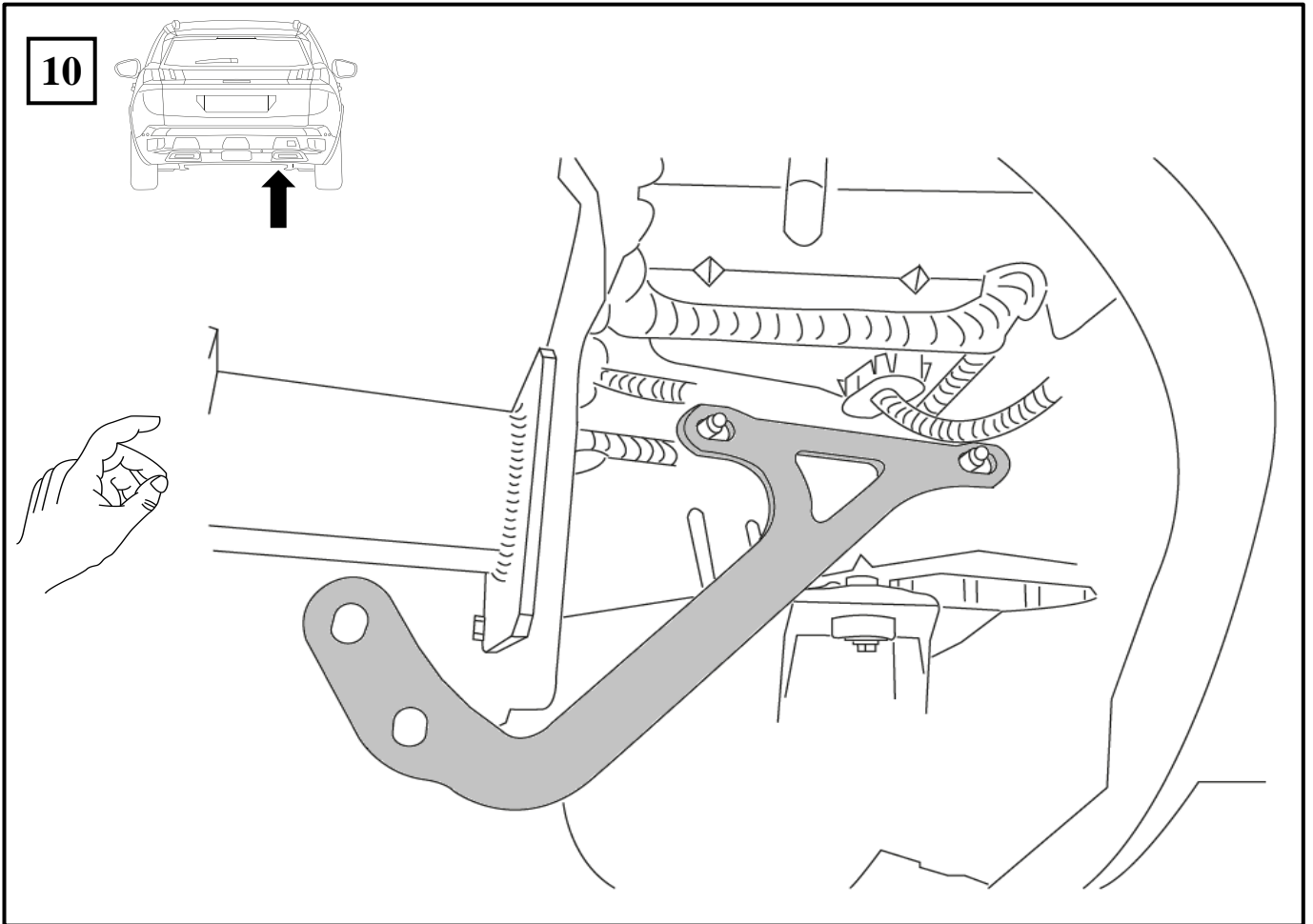
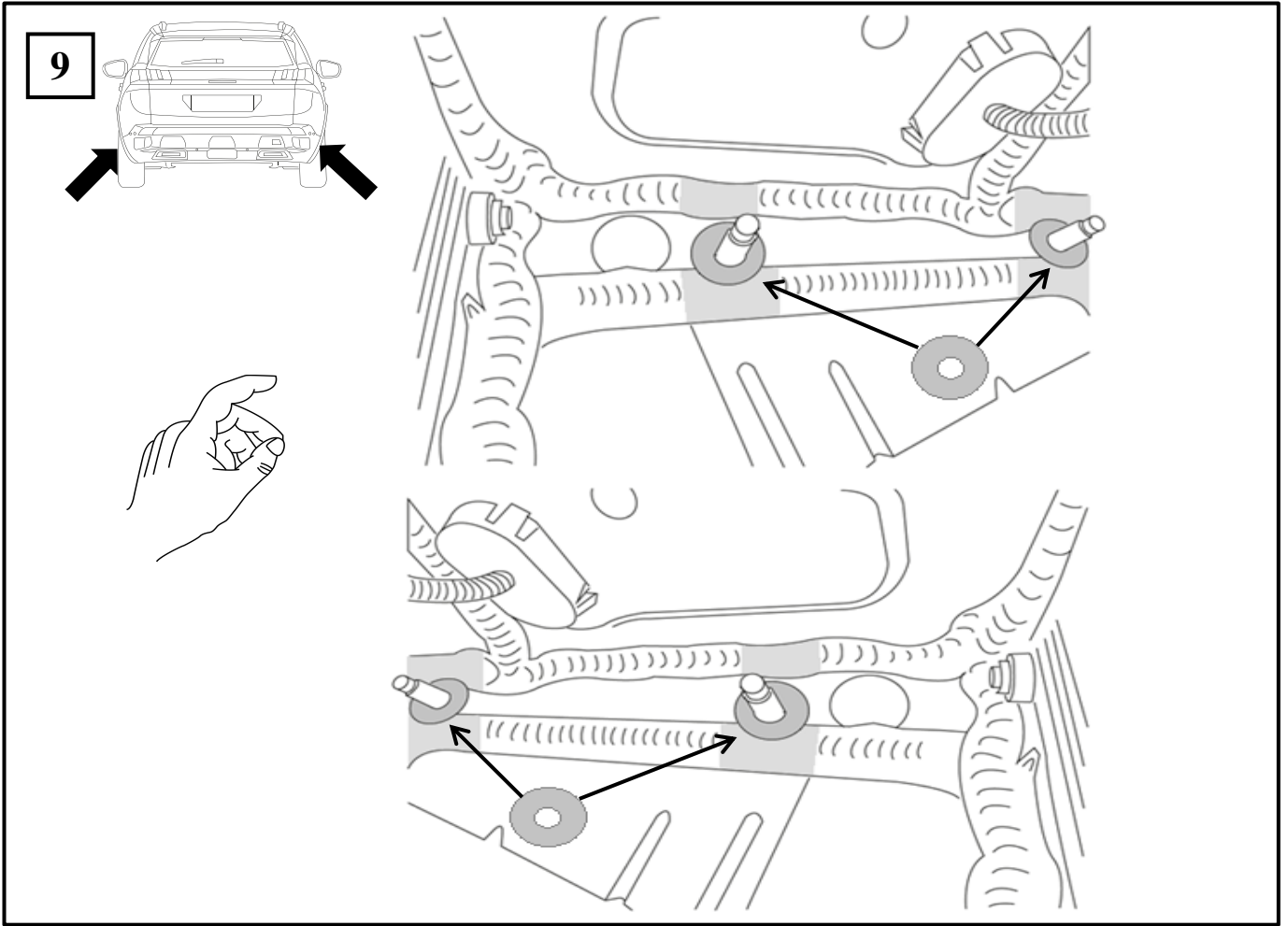

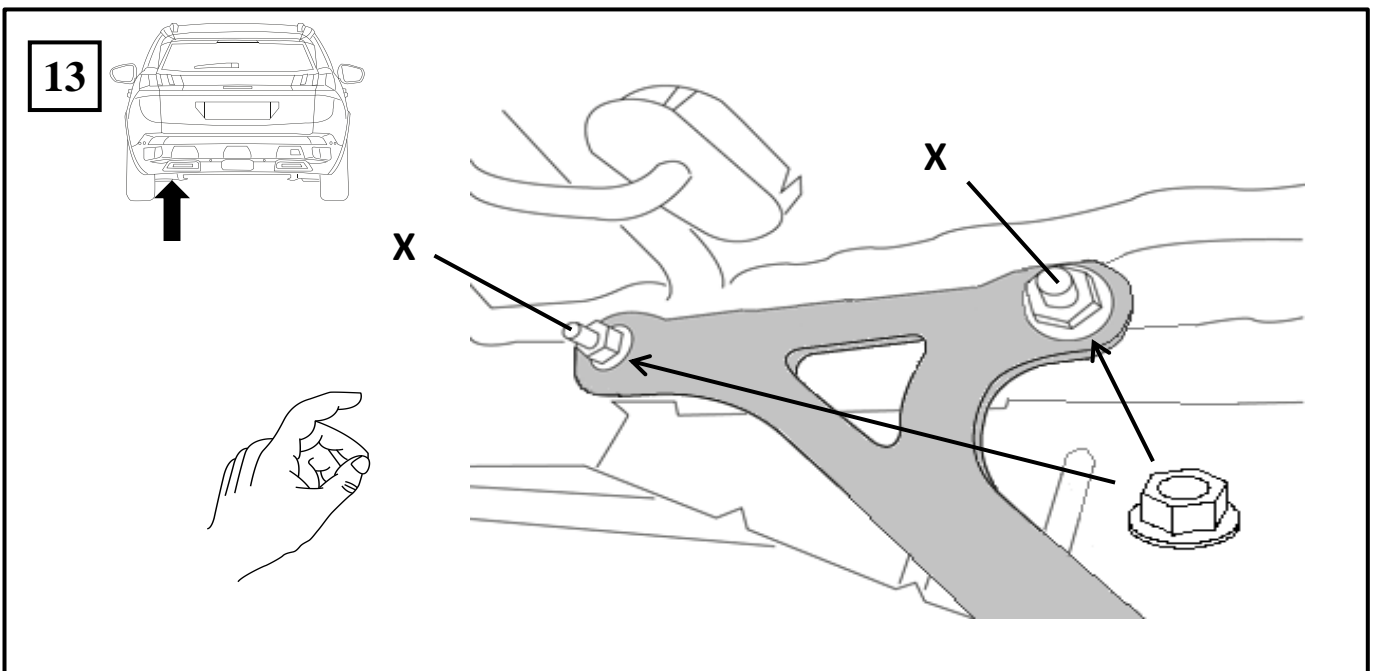
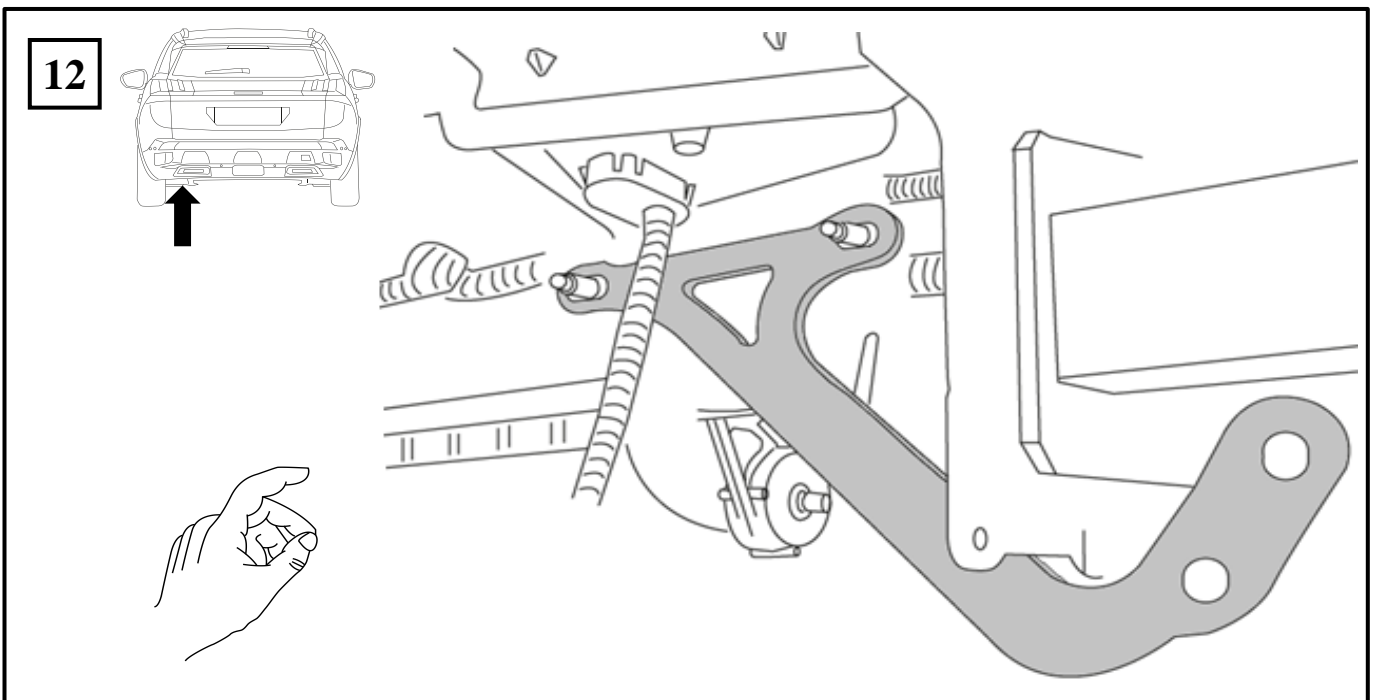
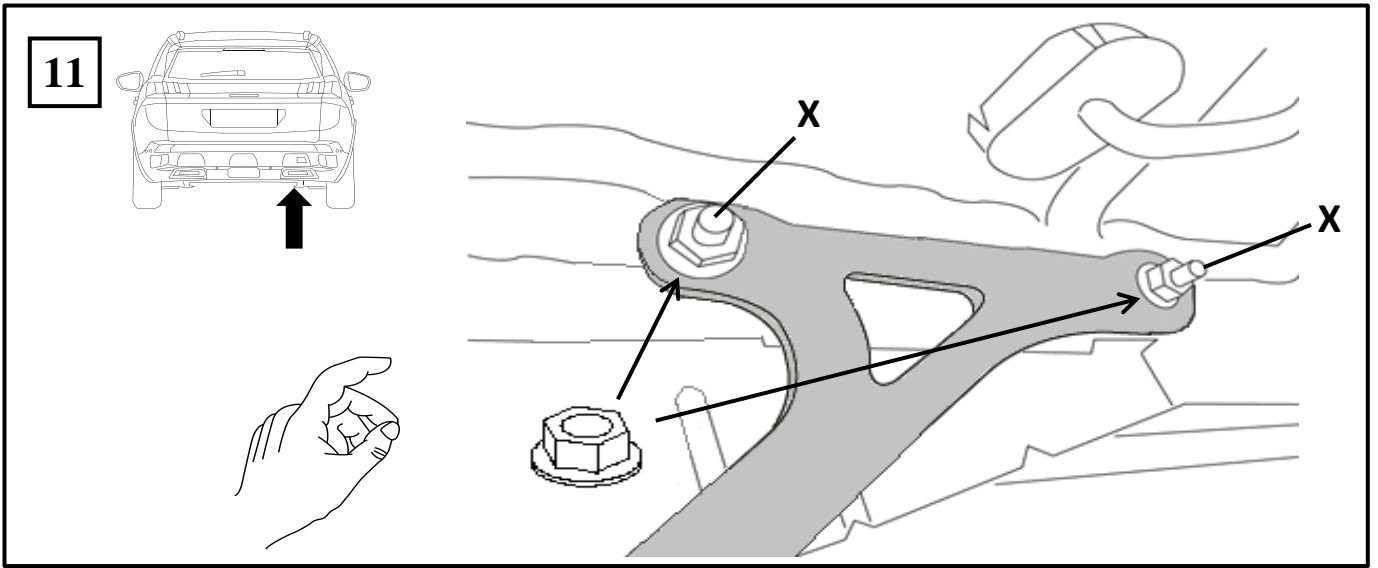

14

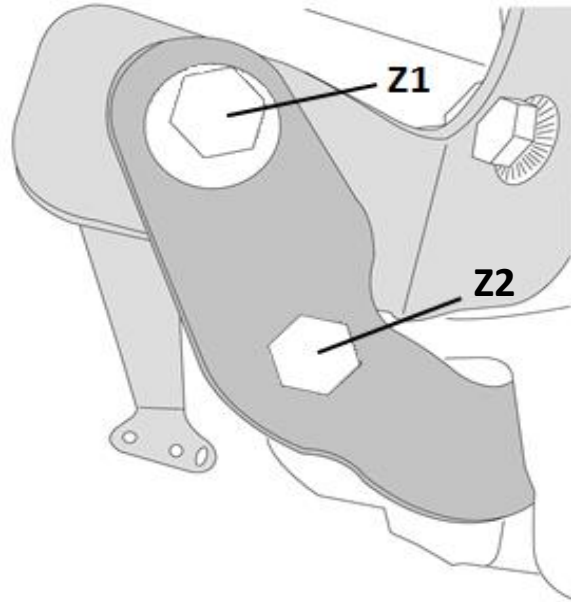

15

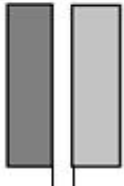
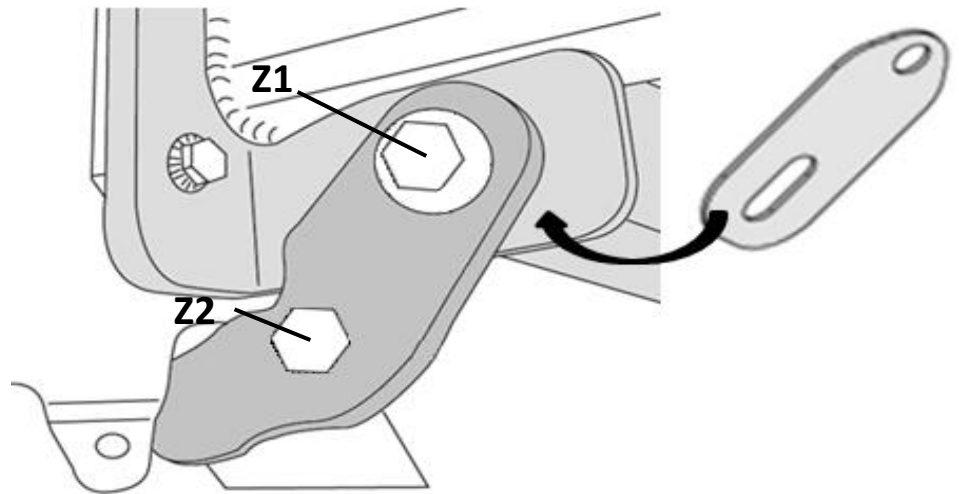

A = ? mm

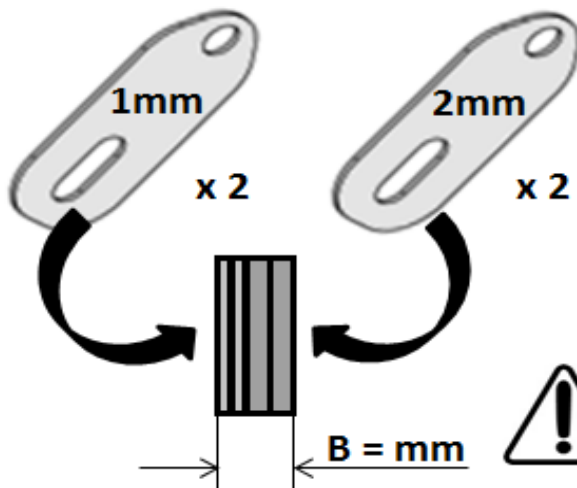
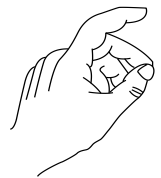

16



1 : 25 Nm
2 : 40 Nm
3 : 110 Nm

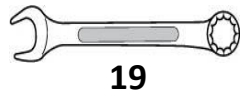
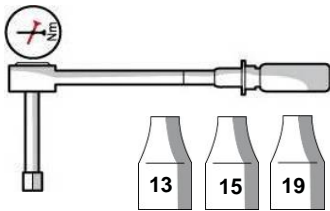
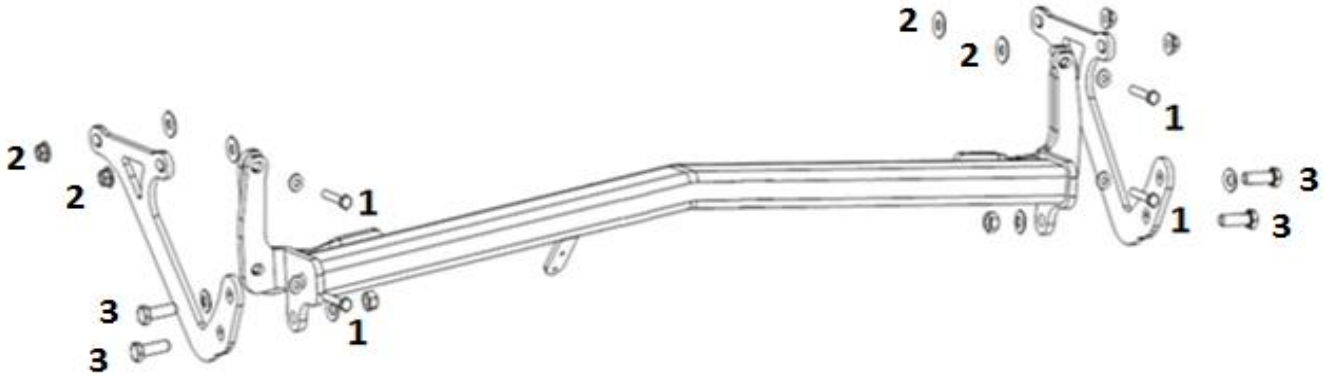

17

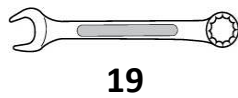
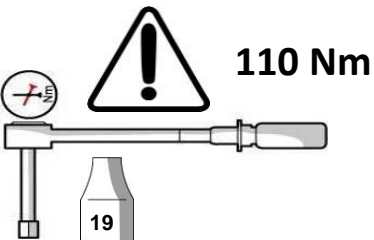
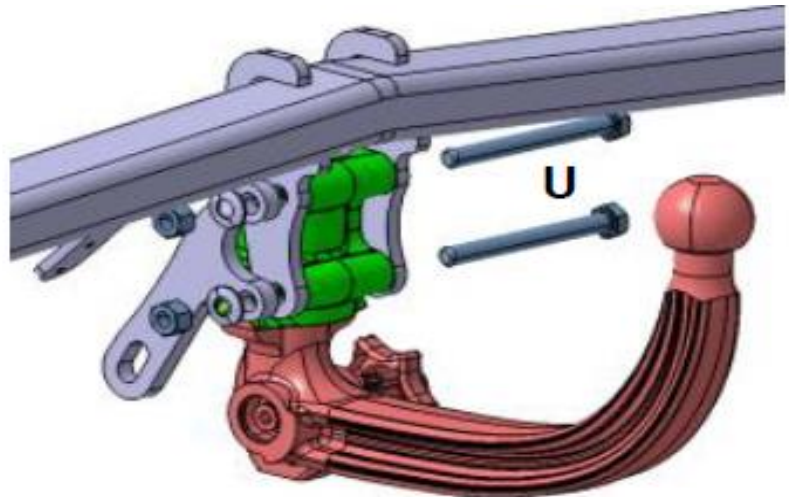

18

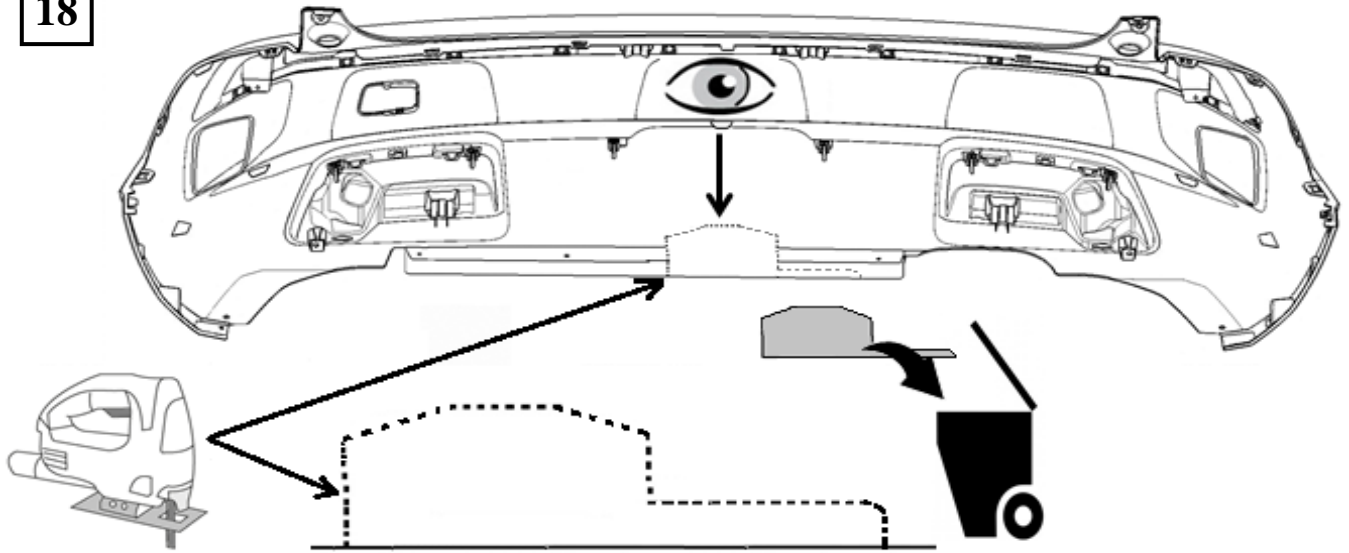

19

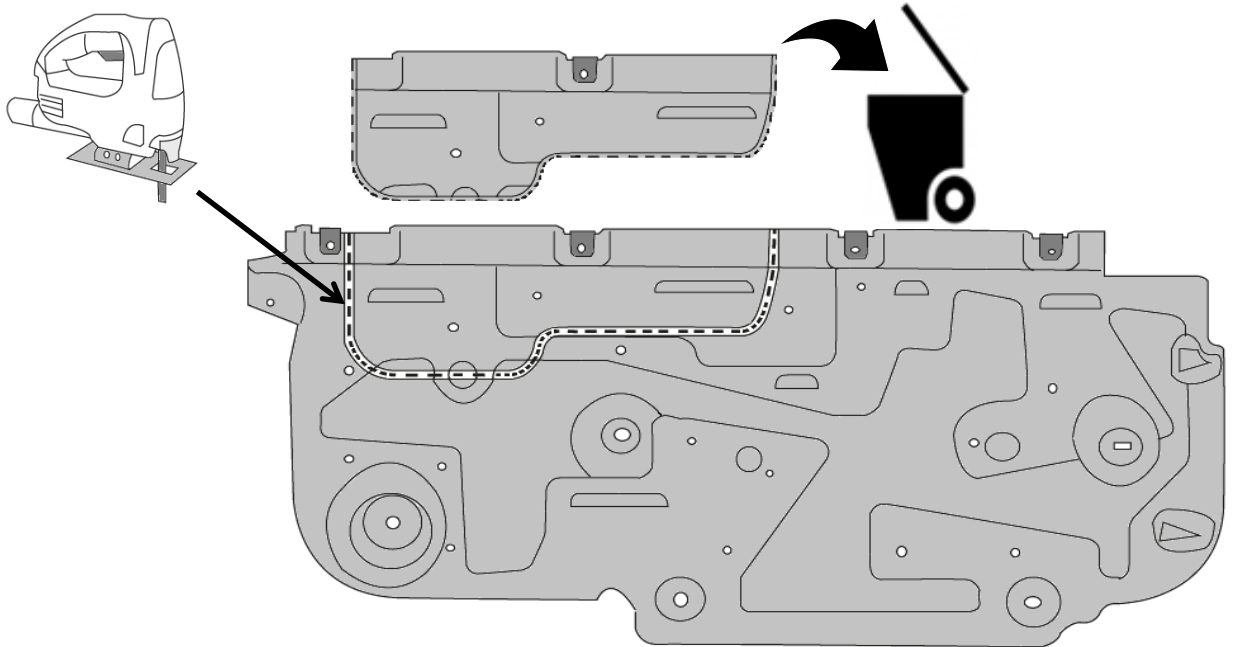

20

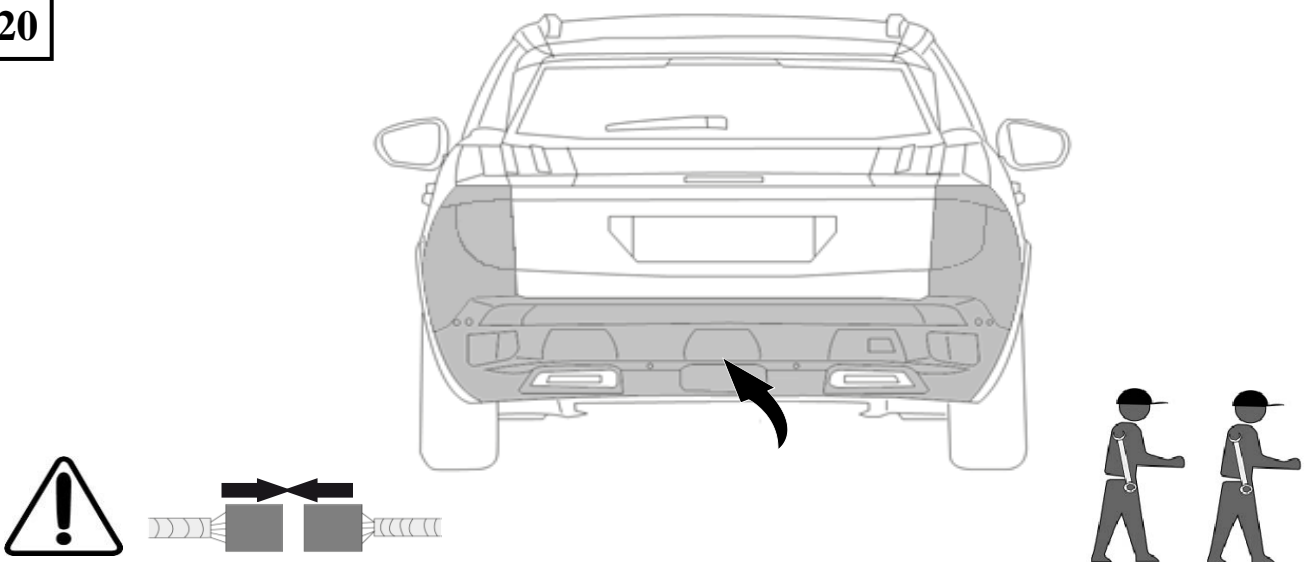

21

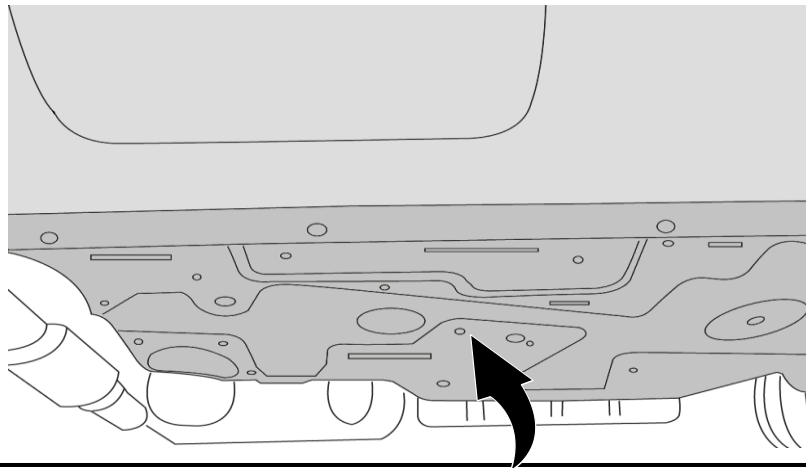

22

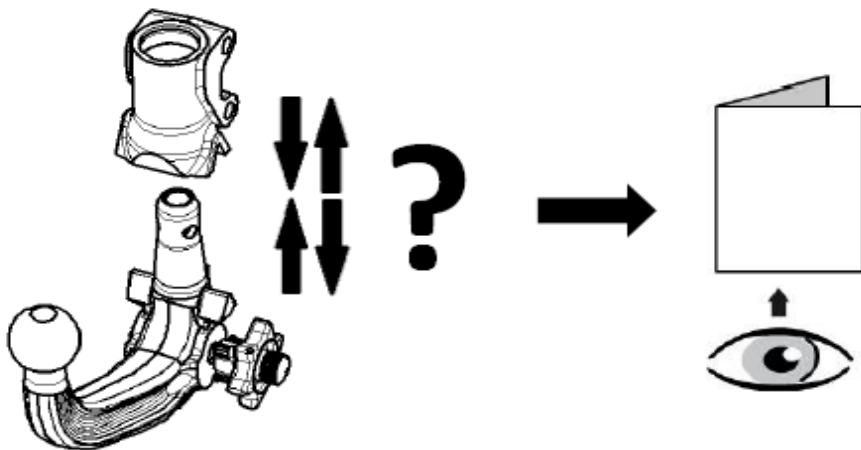

23

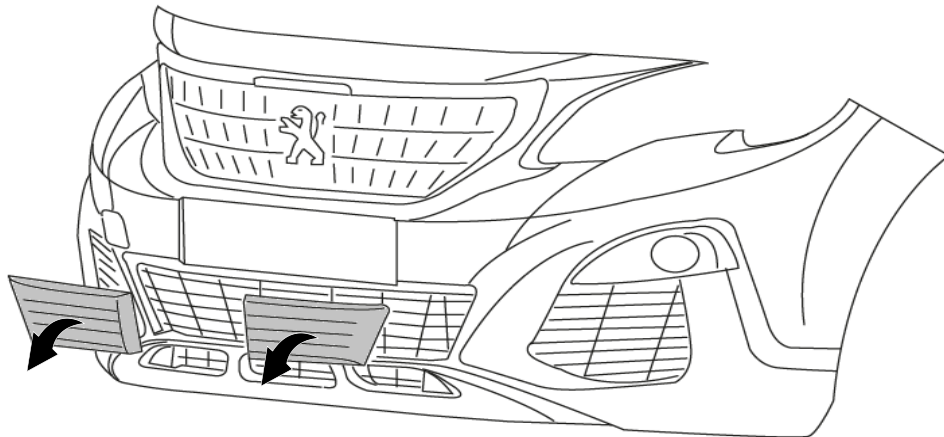
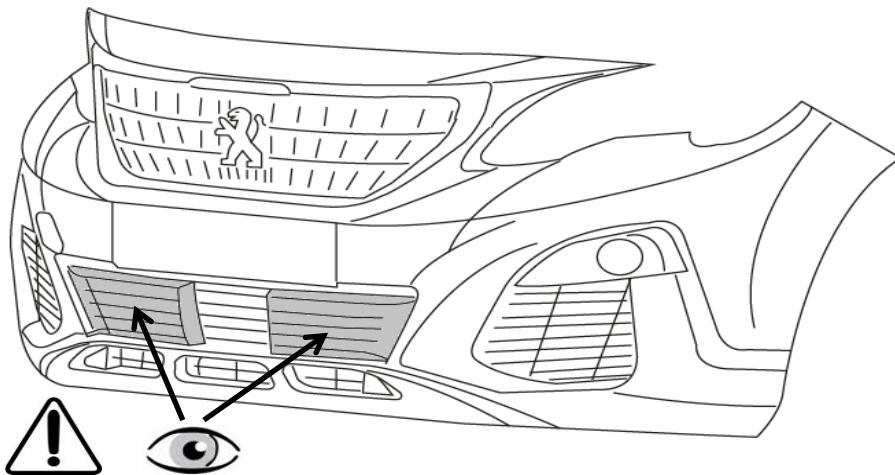
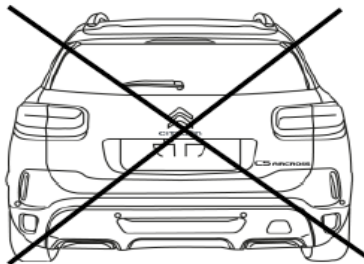

Dispositivo di traino tipo : **315244600001**
Per autoveicolo : **PEUGEOT 3008 - OPEL GRANDLAND X - CITROEN C5 AIRCROSS**
Tipo funzionale : **M*******

Classe e tipo di attacco : **A50-X**
Omologazione : **e13*R55 01 4036**
Valore D : **10,03 kN**
Carico verticale max. S : **80 kg**
Larghezza rimorchiabile per Caravan e T.A.T.S. : 2,55m vedere CARTA di CIRCOLAZIONE VEICOLO (motrice) + 70cm = ...arrotondare ai 5cm superiore (vedi D.M.28/05/85)
Massa rimorchiabile : vedi carta di circolazione dell'autoveicolo

Per verificare l'idoneità del dispositivo di traino omologato a norma CEE R55, all'installazione sulla vettura su cui si intende procedere al montaggio, compilare la seguente formula (se necessario declassare la massa rimorchiabile) :

$$D = \frac{T \times C}{T + C} \times 0,00981 \leq 10,03 \text{ kN}$$

dove : T = Massa Complessiva Max. della motrice (in kg)
C = Massa Rimorchiabile Max. della motrice (in kg)

DA COMPILARE PER IL COLLAUDO

DICHIARAZIONE DI CORRETTO MONTAGGIO : la sottoscritta Ditta dichiara di aver montato in maniera corretta ed in conformità alle prescrizioni sia del costruttore del veicolo che del costruttore del dispositivo stesso il seguente dispositivo di attacco meccanico :

tipo :
Il dispositivo di attacco sopra indicato è stato installato su autoveicolo
modello :
targa :
Data :

TIMBRO e FIRMA

Si dichiara inoltre di aver informato l'utente del veicolo sull'USO e MANUTENZIONE del dispositivo stesso.